





产 品 Group		矩型磁芯 Square drum cores	
形状记录 Shape symbol	HB		
形状 Shape			

产 品 Group	环型磁芯 Ring(Sleeve) cores		
形状记录 Shape symbol	FR		
形状 Shape			

产 品 Group	柱型磁芯 Rod cores	多孔磁芯 Multi-hole cores	
形状记录 Shape symbol	R	PIC	
形状 Shape			



形状 Shape

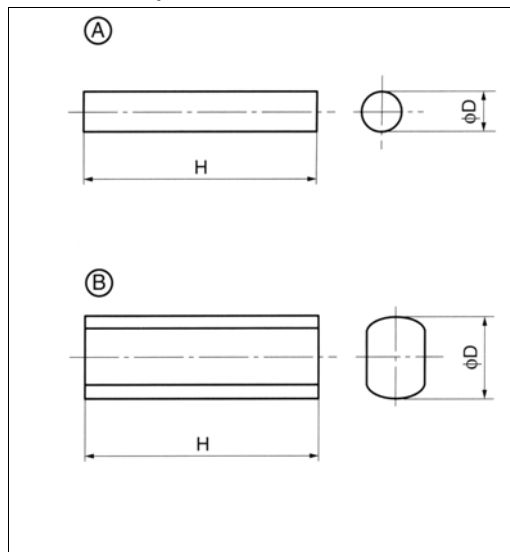

柱型磁芯的产品称呼有以下的命名，采用了以下的命名法
Naming of rod core models

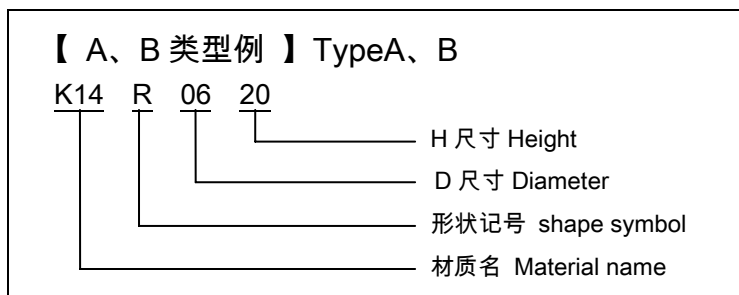

尺寸表 Dimensions(for example)

单位 Unit : mm

品名	ΦD	H	种类
R01811	1.8+0/-0.06	10.8+0/-0.15	A
R0316	3.0±0.3	16.0±0.3	A
R0412	4.0+0.1/-0.2	12.0±0.3	A
R0418	4.0+0 /-0.3	17.9+0/-0.6	A
R0512	5.0±0.15	12.0±0.3	A
R0525	5.0+0/-0.3	25.0±0.5	A
R05515	5.5±0.15	15.0±0.6	A
R05521A	5.5±0.15	21.0±0.6	A
R0615	6.0±0.1	15.0+0.1/-0.3	B
R0619	6.0±0.15	19.0±0.6	A
R0620	6.0+0/-0.3	20.0±1.0	A
R0642	6.0±0.2	42.0±0.4	B
R0738	7.0±0.2	38.0±0.5	B
R1007	10.0±0.2	7.0±0.3	A
R1018	10.0+0/-0.3	18.2±0.2	A
R1020	10.0±0.3	20.0±1.0	A
R1030	10.0±0.3	30.0+0/-2.0	A
R1107A	10.5±0.1	7.2±0.1	B

形状 Shapes

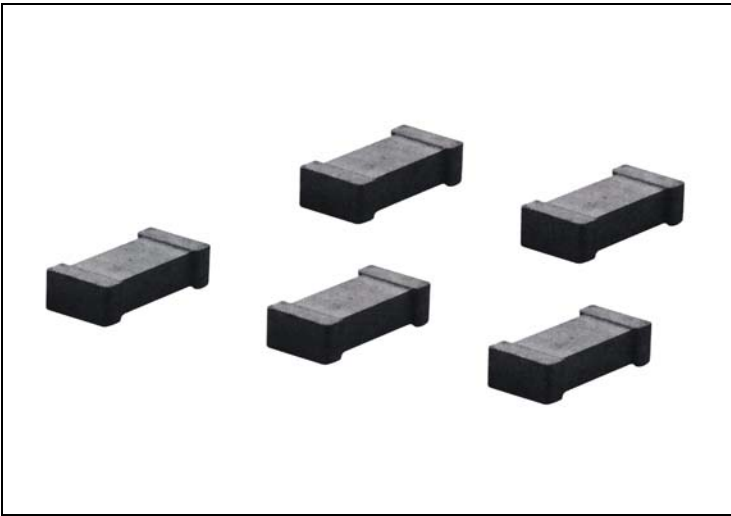

关于矩型磁芯的产品命名

Naming of square drum core models

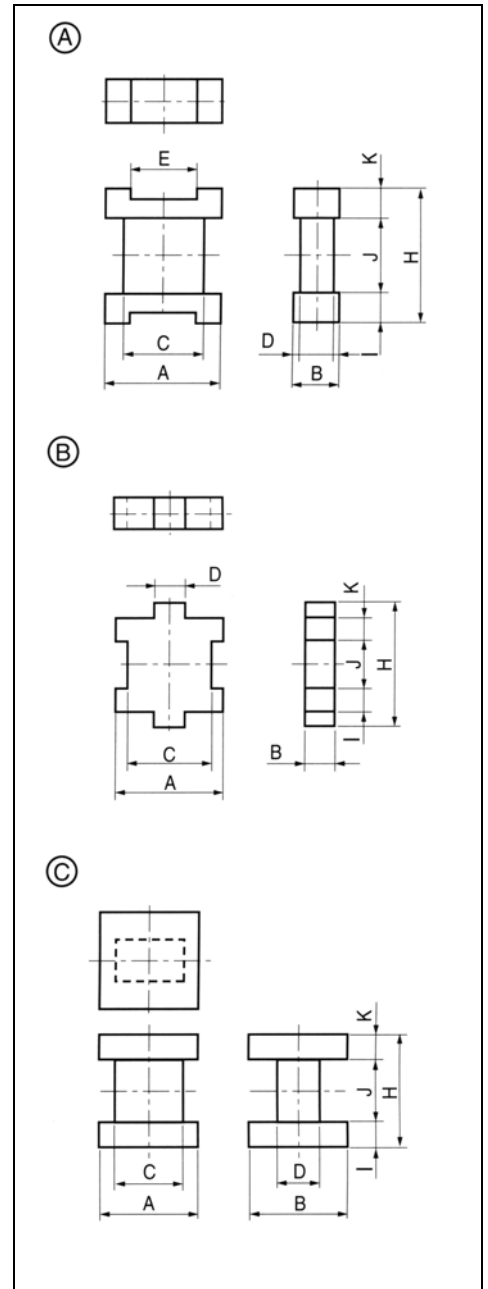
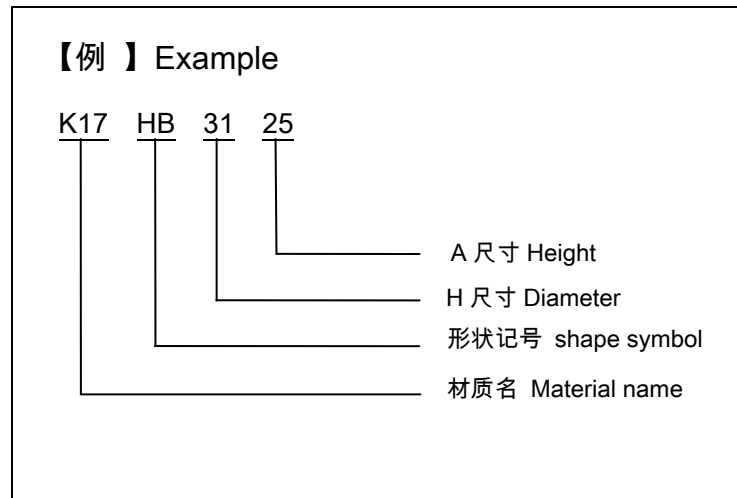

尺寸表 Dimensions(for example)

单位Unit : mm

品名	A	B	C	D	E	H	I	J	K	种类
HB2620	2.0±0.1	0.85+0/-0.1	1.4±0.1	0.6±0.1	/	2.65±0.1	(0.35)	1.3±0.1	(0.35)	B
HB2419	1.9±0.1	1.1±0.1	(0.45)	(0.74)	0.85±0.1	2.4±0.1	(0.425)	1.55±0.1	(0.425)	A
HB3125	2.5±0.1	2.0±0.1	(1.4)	(1.2)	0.95±0.1	3.1±0.1	(0.7)	1.7±0.1	(0.7)	A
HB2013	1.25±0.05	1.25±0.05	1.0±0.30	1.0±0.03	/	2.0±0.1	0.4	1.2-0.1	0.4	C